

DS-TMG420/A/B Barrier Gate with Straight Boom Pole



DS-TMG420-X series barrier gate is applicable to entrance and exit management. It is widely used in road toll stations, parking lots, communities, enterprise entrances and exits, etc. to manage the entering and exiting of vehicles and record vehicle passing times. It can be controlled automatically via parking lot management system, or via handle, remote controller, button, etc.

- Adopts integrated machine core. Parallel gear decelerates linkage arm transmission to ensure stability and efficiency.
- Supports convenient side installation with compact structure.
- Adopts quenching process for carbon steel gear to realize wear-resistant and impact-resistant functions and extend product life.
- Adopts small DC brushless motor with low noise to increase output torque and realize precise intelligent control.
- Supports rebound for obstacle and opening priority.
- Adopts DC variable frequency control to enable smooth operation with fast boom pole opening and slow boom pole closing.
- Supports event log to enable convenient monitoring.
- Supports multiple anti-fall modes such as IR, vehicle detectors, and radars.
- Supports fault code detection on the nixie tube, log record, and abundant status indicating. Based on the fault code displayed on the nixie tube, you can realize quickly problems locating and maintenance.
- Supports manually opening boom pole. You can turn hand wheel to keep barrier gate opening during power cutoff.
- Delayed boom pole closing (10 s delay time by default). Supports 99 shifts (initial status 2 s, 2 s gap between each shift).
- Supports auto boom pole opening during power cutoff. The barrier gate can open automatically to allow fire trucks in (optional components required).
- Intergated with strip light and body indicator to show barrier gate status

▪ Specification

Barrier Housing	
Barrier Housing Material	SGCC
Barrier Housing Thickness	1.5 mm
Barrier Housing Door Thickness	1.2 mm
Barrier Housing Color	Iron gray
Barrier Housing Door Color	Orange red
Boom Pole Installation Height	885 mm
Body Indicators	with body indicator. Green: arrow indicator. Red: prohibition indicator with strip light. Green & Red
Barrier Gate General	
Rising/Falling Speed	3m light pole, right by default, direction switchable Rising Speed: 1.8 S Falling Speed: 1.8 S 4m light pole, right by default, direction switchable Rising Speed: 2.5 S Falling Speed: 2.5 S
Boom Pole Direction	right by default, direction switchable
Motor Type	DC brushless motor
Matched Boom Pole Type	Octagonal straight boom pole: 3 to 4 m
Boom Pole Falling Delay	10 s by default (configurable), min. 2 s (every 2 s followed a gap)
Number of Cycles	5,000,000
Working Voltage	220 VAC
Consumption	Max. 139 W
Temperature and Humidity	Temperature: -30 °C to 60 °C (-22 °F to 140 °F), Humidity: ≤ 90%
Rising Boom Pole for Poweroff	Optional, not supported by default
Package	
Barrier Housing Dimensions (L × W × H)	1060 × 370 × 262 mm (41.73 × 14.57 × 10.31 inch)
Body Weight	43 ± 3 kg (94.8 ± 6.61 lb.)
Body Dimensions (with Package, Without Boom Pole) (L × W × H)	1266 × 504 × 626 mm (49.84 × 19.84 × 24.65 inch)
Body Weight (with Package, Without Boom Pole)	47 ± 3 kg (103.61 ± 6.61 lb.)
Barrier Gate	
Duty Cycle	100%
Interface	
RS-485	1 group
Rising to Limit	1 group
Falling to Limit	1 group
Open	1 group
Close	1 group
Stop	1 group
IR/Vehicle Detector/Radar	1 group
Traffic Signal Light	1 group, external power supply required, max. 220 VAC supported

Approval	
RF	CE-RED EN 300220-1 V3.1.1 EN 300220-2 V3.1.1 EN 301489-1 V2.2.3 EN 301489-3 V2.1.1 EN IEC 62311: 2020
EMC	CE-EMC: EN 55032: 2015/A11: 2020 + A1: 2020, EN IEC 61000-3-2: 2019/A1: 2021, EN 61000-3-3: 2013 + A1: 2019/A2: 2021, EN 50130-4: 2011 + A1: 2014
Security	CE-LVD: EN 62368-1: 2014/A11: 2017 CB: IEC 62368-1: 2014 IEC 62368-1: 2018
Environment	ROHS
Protection	IP54, IK09
Boom Pole	
Boom Pole Color	White background with red bar
Boom Pole Weight	3 m boom pole with LED strip light: 3.4 ± 0.3 kg (7.50 ± 0.66 lb.) 4 m boom pole with LED strip light: 4.4 ± 0.3 kg (9.70 ± 0.66 lb.)
Boom Pole Dimensions (with Package)	3 m boom pole with LED strip light: 100 × 60 × 3035 mm (3.94 × 2.36 × 120.07 inch) 4 m boom pole with LED strip light: 100 × 60 × 4035 mm (3.94 × 2.36 × 159.45 inch)
Boom Pole Weight (with Package)	3 m boom pole with LED strip light: 4.0 ± 0.3 kg (8.82 ± 0.66 lb.) 4 m boom pole with LED strip light: 5.2 ± 0.3 kg (11.46 ± 0.66 lb.)
Color of Boom Pole with LED Strip Light	with LED strip light, green indicator for boom pole opening status Boom pole other status: red indicator Photometric parameters: Red: luminous flux 39.44 lm, light effect 17.86 lm/W Green: luminous flux 107.56 lm, light effect 45.65 lm/W Working life (lighting time): 5800 h
Boom Pole Dimensions	3 m boom pole with LED strip light: 95 × 49 × 3013 mm (3.74 × 1.93 × 118.62 inch) 4 m boom pole with LED strip light: 95 × 49 × 4013 mm (3.74 × 1.93 × 157.99 inch)
Boom Pole Material	AL6061

▪ Available Model

DS-TMG420/A/B(3m light pole)
DS-TMG420/A/B(4m light pole)
DS-TMG420/A/B(3m/24V light)
DS-TMG420/A/B(4m/24V light)

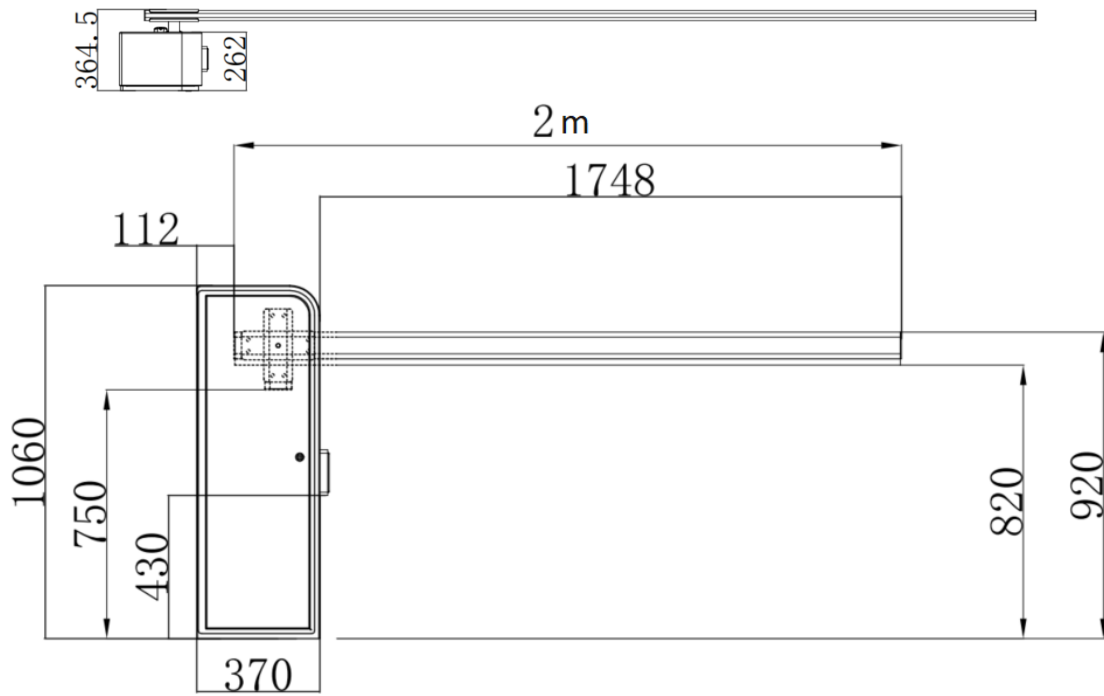
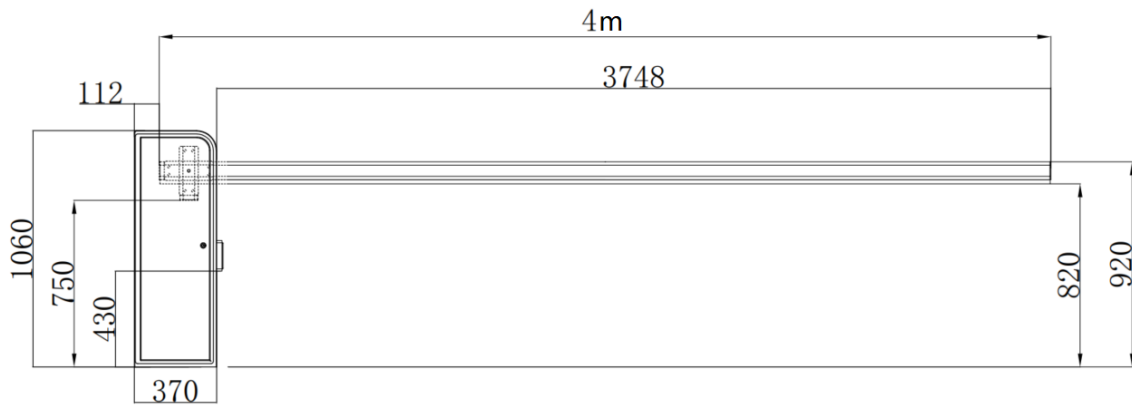

▪ Dimension

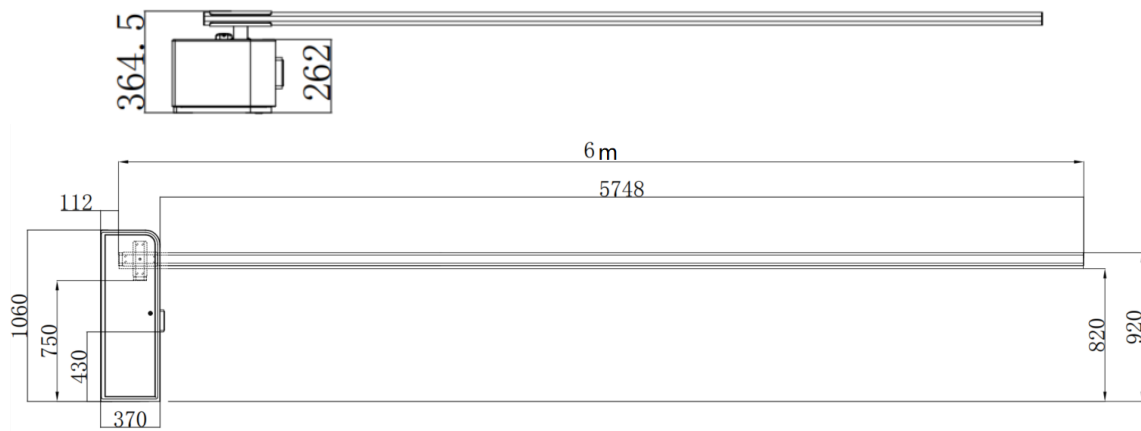
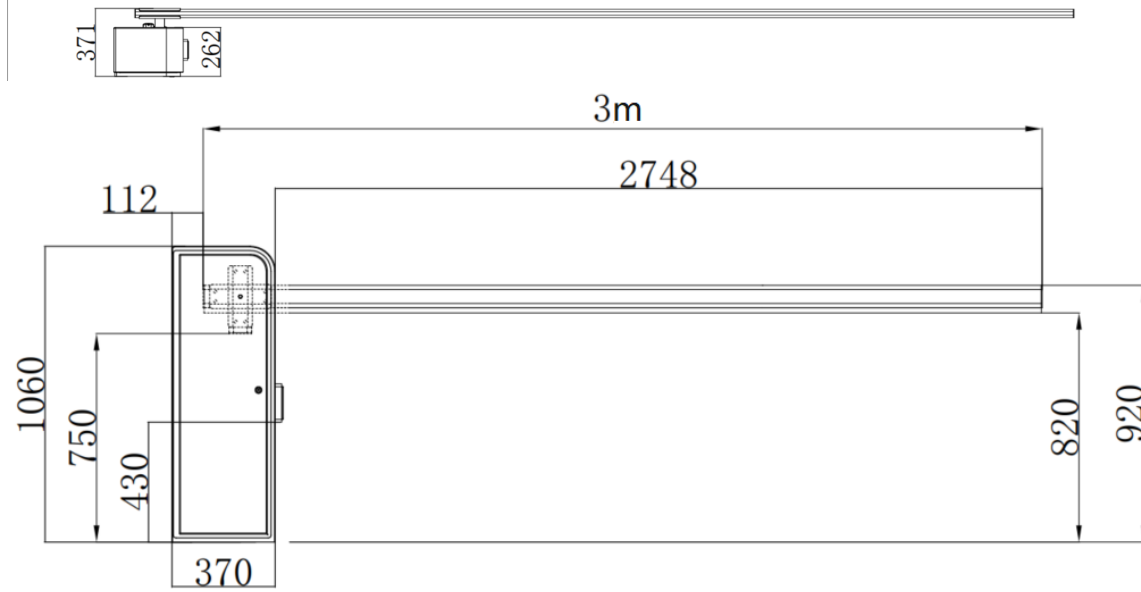
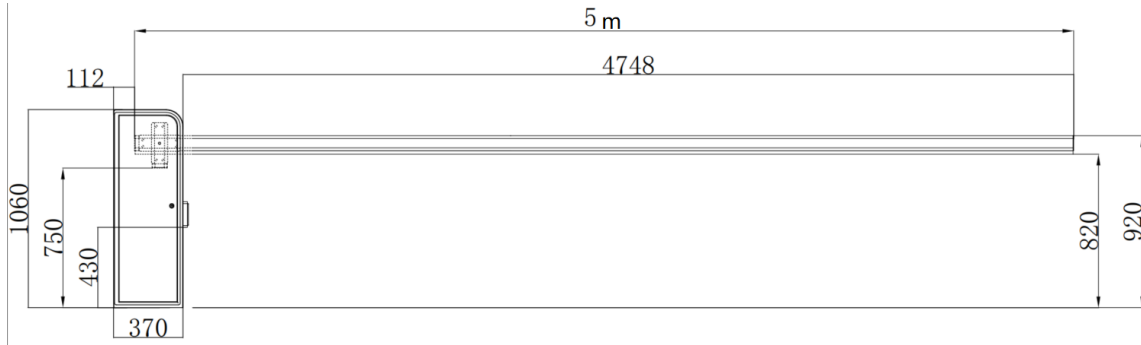



▪ **Accessory**

▪ **Included**

DS-TMG012-5 Remote Controller	DS-TMG001-3 Straight Pole with Light
	

▪ **Optional**

EEBracket-L800-100 0(barrier) Barrier Pole	TMG080-3 TMG080-3	DS-TMG070/4B/42(24V) Barrier Gate Indicator	DS-TMG060-42 Barrier Gate Supercapacitor Board	DS-TMG050 Pull Rod Antenna Assembly
				
DS-TMG000-2-R/L(L ow speed)	DS-TMG000-2-R/L(high speed)	DS-TMG022 Coil Vehicle Detector	DS-TMG023 Coil	DS-TVL221-1-6D Entrance & Exit Signal Light
				

Headquarters

No.555 Qianmo Road, Binjiang District,
Hangzhou 310051, China
T +86-571-8807-5998
www.hikvision.com



Follow us on social media to get the latest product and solution information.

