

## DS-2SF8C425MXG-EL/26 4 MP 25 × TandemVu PTZ Camera



Hikvision has been dedicated to develop products with security since established. Hikvision always follows security by design principle and has adopted many methods of security technologies into our product development lifecycle, including terminal security, data security, application security, network security, and privacy protection. In the meantime, the security technologies used by Hikvision are all in compliance with local applicable laws and safety regulations. These security measures could enhance product's cyber security defense capability and protect your devices as well as your data from malicious cyber attacks.

- Captures a large area and great details at the same time
- High quality imaging with 6 MP resolution for bullet channel
- 24/7 colorful imaging and excellent low-light performance with DarkFighter technology
- Panoramic channel tilt adjustable from 12° to 24°
- Secures an expansive area with 25 × optical zoom and 16 × digital zoom
- Expansive night view with up to 30 m white light distance and 300 m IR distance
- Supports deep learning functions
- Water and dust resistant (IP67) and vandal resistant (IK10)

## ▪ Specification

Camera	
Image Sensor	[Panoramic channel] 1/1.8" Progressive Scan CMOS, [PTZ channel] 1/1.8" Progressive Scan CMOS
Min. Illumination	[PTZ channel] Color: 0.0005 Lux @ (F1.3, AGC ON), B/W: 0.0001 Lux @ (F1.3, AGC ON), 0 lux with IR,[Panoramic channel] Color: 0.005 Lux @ (F1.4, AGC ON), B/W: 0.001 Lux @ (F1.4, AGC ON), 0 Lux with light
Shutter Speed	1 s to 1/30000 s
Slow Shutter	Yes
Day & Night	[Panoramic channel] Color, [PTZ channel] IR cut filter
Zoom	[PTZ channel] 25 × optical, 16 × digital
Max. Resolution	[Panoramic channel] 3632 × 1632, [PTZ channel] 2560 × 1440
Lens	
FOV	[Panoramic channel] horizontal field of view: 190° ± 5°, vertical field of view: 80° ± 5°, [PTZ channel] horizontal field of view: 58.5° to 3.1°, vertical field of view: 34° to 1.7°, diagonal field of view: 65.8° to 3.5°
Zoom Speed	[Panoramic channel] No, [PTZ channel] approx. 5.6 s
Focus	Auto,semi-auto,manual
Focal Length	[Panoramic channel] 2.8 mm, [PTZ channel] 6 to 150 mm
Aperture	[Panoramic channel] F1.0, [PTZ channel] F1.6
Illuminator	
Supplement Light Range	[Panoramic channel] white light: up to 30 m, [PTZ channel] IR: up to 300 m
Smart Supplement Light	Yes
PTZ	
Movement Range (Pan)	360° endless
Movement Range (Tilt)	[Panoramic channel] 12° to 24°, [PTZ channel] -20° to 90°
Pan Speed	[PTZ channel] pan speed: configurable from 0.1° to 160°/s, preset speed: 240°/s
Tilt Speed	[PTZ channel] tilt speed: configurable from 0.1° to 120°/s, preset speed 200°/s,[Panoramic channel] tilt speed configurable
Proportional Pan	[Panoramic channel] No, [PTZ channel] Yes
Presets	300
Patrol Scan	8 patrols, up to 32 presets for each patrol
Pattern Scan	4 pattern scans, record time over 10 minutes for each scan
Power-off Memory	Yes
Park Action	Preset,pattern scan,patrol scan,auto scan,tilt scan,random scan,frame scan,panorama scan
3D Positioning	Yes
PTZ Status Display	Yes
Preset Freezing	Yes
Scheduled Task	Preset,pattern scan,patrol scan,auto scan,tilt scan,random scan,frame scan,panorama scan,dome reboot,dome adjust,aux output
Video	
Main Stream	[PTZ channel] 50 Hz: 25 fps (2560 × 1440, 1920 × 1080, 1280 × 960, 1280 × 720), 60 Hz: 30 fps (2560 × 1440, 1920 × 1080, 1280 × 960, 1280 × 720),[Panoramic channel] 50 Hz: 25 fps (3680 × 1656, 3632 × 1632), 60 Hz: 30 fps (3680 × 1656, 3632 × 1632)

Sub-Stream	[PTZ channel] 50 Hz: 25 fps (704 × 576, 640 × 480, 352 × 288), 60 Hz: 30 fps (704 × 576, 640 × 480, 352 × 288),[Panoramic channel] 50 Hz: 25 fps (1200 × 536, 960x432), 60 Hz: 30 fps (200 × 536, 960 × 432)
Third Stream	[PTZ channel] 50 Hz: 25 fps (1920 × 1080, 1280 × 960, 1280 × 720, 704 × 576, 640 × 480, 352 × 288), 60 Hz: 30 fps (1920 × 1080, 1280 × 960, 1280 × 720, 704 × 480, 640 × 480, 352 × 240),[Panoramic channel] No
Video Compression	Main stream: H.265+/H.265/H.264+/H.264, Sub-stream: H.265/H.264/MJPEG, Third stream: H.265/H.264/MJPEG
Video Bit Rate	32 Kbps to 16 Mbps
H.264 Type	Baseline profile,Main profile,High profile
H.265 Type	Main profile
Scalable Video Coding (SVC)	H.264 and H.265 encoding
Region of Interest (ROI)	8 fixed regions for each stream
<b>Audio</b>	
Audio Compression	G.711,G.722.1,G.726,MP2L2,PCM,AAC-LC
Audio Bit Rate	32 to 192 Kbps (MP2L2),16 to 64Kbps (AAC-LC)
Audio Sampling Rate	8 kHz,16 kHz,32 kHz,48 kHz
Environment Noise Filtering	Yes
<b>Network</b>	
API	ISAPI,SDK,ISUP,ONVIF
Network Storage	NAS (NFS, SMB/CIFS),auto network replenishment (ANR)
Protocols	IPv4/IPv6,HTTP,HTTPS,802.1X,QoS,SMTP,UPnP,SNMP,DNS,DDNS,NTP,RTSP,RTCP,RTP,TCP/IP,UDP,IGMP,ICMP,DHCP,PPPoE,Bonjour,FTP
Simultaneous Live View	Up to 20 channels
User/Host	Up to 32 users. 3 user levels: administrator, operator, and user
Security	Password protection,complicated password,IP address filter,HTTPS encryption,802.1X authentication (EAP-TLS, EAP-LEAP, EAP-MD5),host authentication (MAC address),watermark
Client	iVMS-4200,HikCentral Pro,Hik-Connect
Web Browser	IE 10+, Chrome 57+, Firefox 52+, Safari 12+
<b>Image</b>	
Wide Dynamic Range (WDR)	[Panoramic channel] 120 dB, [PTZ channel] 120 dB
Day/Night Switch	Day,night,auto,schedule
Image Enhancement	HLC,3D DNR
Privacy Mask	[Panoramic channel] 8 programmable polygon privacy masks, [PTZ channel] 24 programmable polygon privacy masks; mask color or mosaic configurable
Defog	Optical defog,Digital defog
Image Stabilization	EIS (Built-in gyroscope to improve EIS performance)
Regional Exposure	Yes
Regional Focus	[Panoramic channel] No, [PTZ channel] Yes
Image Settings	Saturation, brightness, contrast, sharpness, gain, and white balance adjustable by client software or web browser
Image Parameters Switch	Yes
SNR	≥ 52 dB

Supplement Detection	
Satellite Positioning	No
Gyroscope	Yes
Compass	No
Interface	
Ethernet Interface	1 RJ45 100M self-adaptive Ethernet port
On-board Storage	Built-in memory card slot, support microSD/microSDHC/microSDXC card, up to 256 GB
Alarm	7 input(s), 2 output(s)
Audio	1 input (line in), max. input amplitude: 2-2.4 vpp, input impedance: 1 K $\Omega$ $\pm$ 10%, 1 output (line out), line level, output impedance: 600 $\Omega$
RS-485	1 RS-485 (Half duplex, HIKVISION, Pelco-P, Pelco-D, self-adaptive)
Reset	Yes
Event	
Basic Event	[PTZ channel & panoramic channel] alarm input and output, exception,[PTZ channel] video tampering alarm
Smart Event	[Panoramic channel] line crossing detection, intrusion detection, region entrance detection, region exiting detection,[PTZ channel] line crossing detection, intrusion detection, region entrance detection, region exiting detection
Linkage	[Panoramic channel] Upload to FTP/NAS/memory card, notify surveillance center, send email, trigger alarm output, trigger recording, audible warning, white light flashing, [PTZ channel] Upload to FTP/NAS/memory card, notify surveillance center, send email, trigger alarm output, trigger recording, and PTZ actions (such as preset, patrol scan, pattern scan)
Smart Tracking	[PTZ channel] yes
Smart Linkage	Manual tracking, tracking takeover, linked tracking capture
Deep Learning Function	
Multi-Target-Type Detection	[PTZ channel] Supports simultaneous detection and capture of human body and face
Perimeter Protection	PTZ and Panoramic channel both support
General	
General Function	mirror,password protection
Power	36 VDC $\pm$ 25%, max. 60 W, Hi-PoE,including max. 6 W for heater and max. 3 W for supplement light of panoramic channel, and max. 6 W for heater and max. 12 W for supplement light of PTZ channel
Operating Condition	-40 $^{\circ}$ C to 70 $^{\circ}$ C (-40 $^{\circ}$ F to 158 $^{\circ}$ F). Humidity 95% or less (non-condensing),For speaker: -30 $^{\circ}$ C to 55 $^{\circ}$ C (-22 $^{\circ}$ F to 131 $^{\circ}$ F)
Wiper	No
Demist	Yes
Material	ADC12
Dimension	$\varnothing$ 290 mm $\times$ 453.2 mm ( $\varnothing$ 11.42" $\times$ 17.84")
Weight	Approx. 10.5 kg ( 23.15 lb.)
Language	33 languages: English, Russian, Estonian, Bulgarian, Hungarian, Greek, German, Italian, Czech, Slovak, French, Polish, Dutch, Portuguese, Spanish, Romanian, Danish, Swedish, Norwegian, Finnish, Croatian, Slovenian, Serbian, Turkish, Korean, Traditional Chinese, Thai, Vietnamese, Japanese, Latvian, Lithuanian, Portuguese (Brazil), Ukrainian

Approval	
EMC	FCC (47 CFR Part 15, Subpart B),CE-EMC (EN 55032: 2015, EN 61000-3-2: 2019, EN 61000-3-3: 2013 + A1: 2019, EN 50130-4: 2011 + A1: 2014),RCM (AS/NZS CISPR 32: 2015),IC (ICES-003: Issue 7),KC (KN 32: 2015, KN 35: 2015)
Safety	UL (UL 62368-1),CB (IEC 62368-1: 2014 + A11),CE-LVD (EN 62368-1: 2014/A11: 2017),BIS (IS 13252 (Part 1): 2010/IEC 60950-1: 2005),LOA (IEC/EN 60950-1)
Environment	CE-RoHS (2011/65/EU),WEEE (2012/19/EU),Reach (Regulation (EC) No 1907/2006)
Protection	IP67 (IEC 60529-2013),TVS 6000 V lightning protection, surge protection and voltage transient protection,IK10 (IEC 62262:2002)

## ▪ DORI

The DORI (detect, observe, recognize, identify) distance gives the general idea of the camera ability to distinguish persons or objects within its field of view. It is calculated based on the camera sensor specification and the criteria given by EN 62676-4: 2015.

DORI	Detect	Observe	Recognize	Identify
Definition	25 px/m	63 px/m	125 px/m	250 px/m
[Bullet channel] Distance	77.0m	30.5m	15.4m	7.7m
[PTZ channel] Distance (Tele)	2965.5m	1176.8m	593.1m	296.6m

## ▪ Available Model

DS-2SF8C425MXG-EL/26(F0)





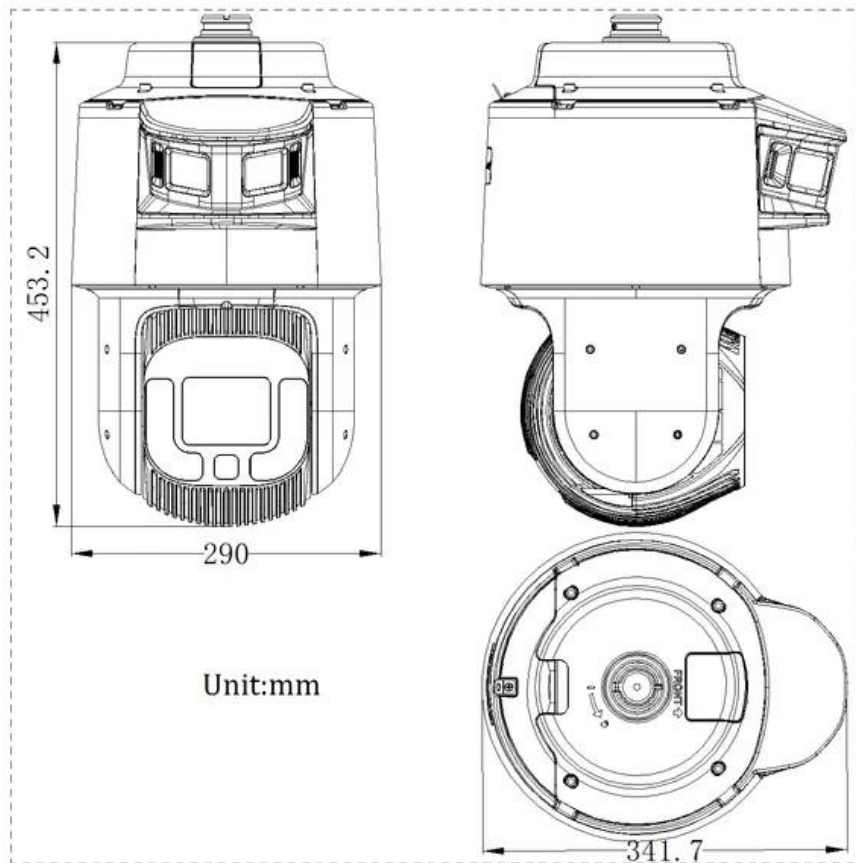





DS-2SF8C425MXG-EL/26(F0)(B)

## ▪ Dimension



▪ **Accessory**

▪ **Optional**

DS-1603ZJ-P Wall mount	DS-1668ZJ-P Pendant Mount	DS-1668ZJ(20)-P Pendant Mount	DS-1673ZJ-P Vertical pole mount	DS-1603ZJ-Pole-P Vertical pole mount
				
				
<b>DS-1619ZJ-HP2</b> Others	<b>DS-1684ZJ-P</b> Vertical pole mount			



**Headquarters**

No.555 Qianmo Road, Binjiang District,  
Hangzhou 310051, China  
T +86-571-8807-5998  
www.hikvision.com



Follow us on social media to get the latest product and solution information.

