

Quick Start Guide

Smart Wire-Free Security Camera System

Setup Video
Scan QR code or visit
<https://www.tp-link.com/support/setup-video/#cloud-cameras>



7106510466 REV1.3.1 *Images may differ from your actual product.

01 / Charge the Battery

Method 1: Battery

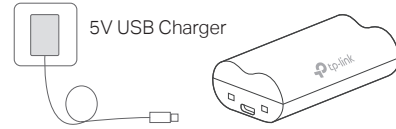

- **Charging:** Solid amber
- **Fully charged:** Solid green

Method 2: Battery Inside Camera

*Check the battery status in the Tapo app after setup.

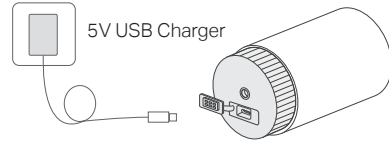

- Note:
1. Charge the battery before use. This will take about 5~6 hours.
 2. If you want to use the camera while charging the battery, we recommend purchasing another battery for your convenience.
 3. Charge the battery using the USB cable and charger included in the package. Inappropriate cables may result in slow charging or failure to charge.

02 / Insert the Battery

1. Twist anti-clockwise and then pull to remove the cover of the camera. Insert the battery.

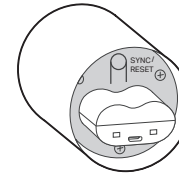

2. Align the indicator line on the cover with the arrow icon on the camera body. Press and rotate clockwise to the lock position to replace the cover.

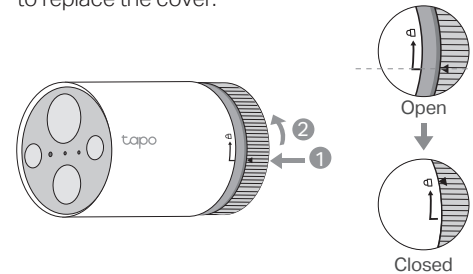

03 / Set Up Hub and Camera

1. Get the Tapo app from the App Store or Google Play.



2. Follow the instructions in the Tapo app to set up your hub.



3. Follow the instructions in the Tapo app to set up your camera.

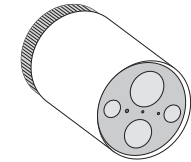

04 / Installation Options

Option 1. Set on a Table

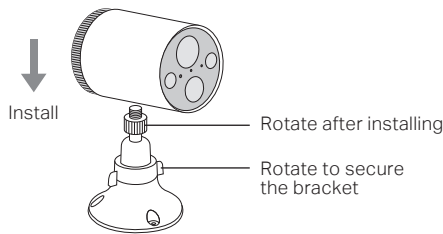

Option 2. Mount to the Wall

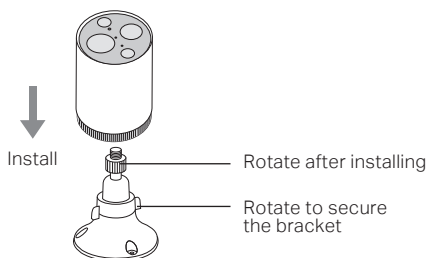

05 / Mounting Tips

1. Avoid placing behind glasses. Glasses will block the motion sensor of your camera.
2. Choose a proper location to mount your camera, or it will be triggered too often by false alarms.
 - Avoid pointing the camera directly at swaying trees.
 - Avoid pointing the camera directly at vehicles and pedestrians on the road.
 - Avoid pointing the camera directly at street lamps and sunlight.
3. Mount your camera to the side so that movement goes across the lens' field of view to better trigger motion detection and AI detection.

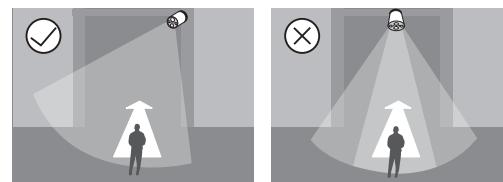

*Do not mount facing the direction of movement.

4. The camera should be placed 7-10 ft (2-3 m) above the ground.
5. Tilt the camera downwards at an angle of about 20° ~ 25°.

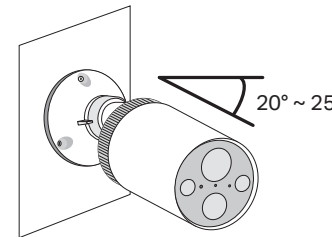

6. Keep the motion sensor level for best results.

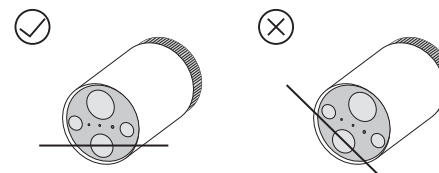

7. Do not place the camera upside down.

06 / Mount to the Wall

1. Drill Holes

Stick the mounting template to the desired mounting place. Drill 3 holes according to the template.

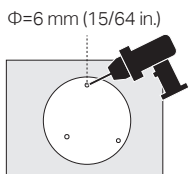

2. Install the Bracket

Insert three anchors into the holes and use the screws to affix the bracket over the anchors.

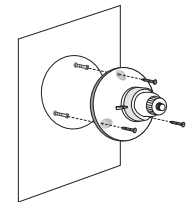

3. Install the Camera

Install the camera on the mounting bracket, and adjust the camera angle.

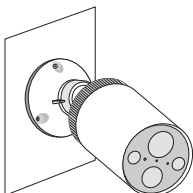

Have a Tapo Solar Panel?

The Tapo Solar Panel charges your Smart Wire-Free Security Camera continuously.

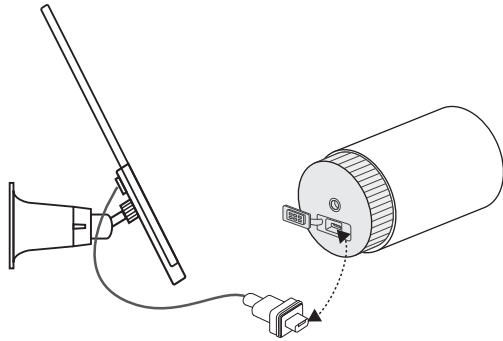

If you don't yet have a Tapo Solar Panel, charge the rechargeable battery with a **standard and high-quality DC 5V/1A battery charger**. Keep the charging port firmly covered when fully charged.

Note: If you use a third-party solar panel to charge this camera, we cannot guarantee the waterproof performance.

Camera Appearance

Front

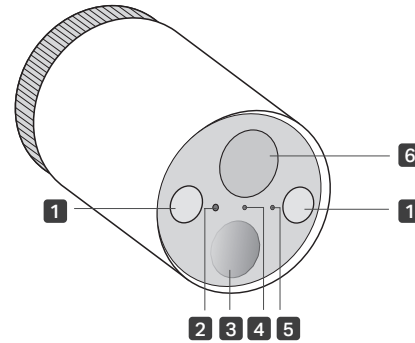

1 Spotlights

2 Light Sensor

3 Motion Sensor

4 Status LED

5 Microphone

6 Lens

Indicate the status of your camera.

Back

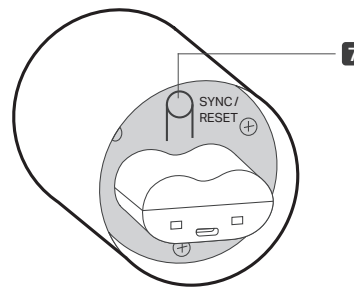

7 SYNC/RESET Button

While the camera is powered on:

Press for **1 second**: Pair with the hub

Press and hold for **at least 5 seconds**: Reset the camera

Hub Appearance

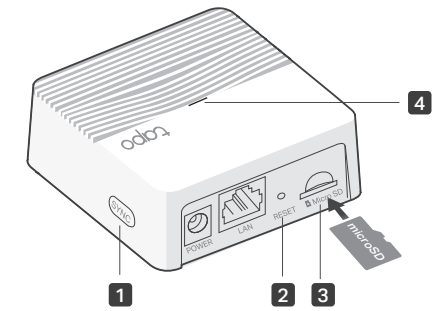

1 SYNC Button

Press to pair with the camera, or silence the hub when it rings.

2 RESET

Use a pin to press and hold for at least 5 seconds until the hub LED quickly blinks red to reset the hub.

3 microSD Card Slot

Insert a microSD card to record camera videos locally. Initialize the microSD card within the Tapo app first.

*microSD card not included.

4 Status LED

Indicate the status of your hub.

Light Indications

Hub Status LED

Solid red	Starting up
Blinking red and green	Ready for setup
Solid amber	Connected to router
Solid green	Connected to the cloud
Blinking green slowly	Pairing
Blinking red quickly	Hub resetting
Blinking green quickly	Hub updating

Camera Status LED

Solid Red	Starting up
Blinking red and green	Ready for pairing
Blinking green slowly	Pairing
Solid amber	Connected to the hub
Solid green	Connected to the cloud
Blinking red quickly	Camera resetting
Blinking green quickly	Camera updating
Blinking red once a minute	Low battery
Blinking red slowly	Offline

Safety Information

- Do not use damaged charger or USB cable to charge the device.
- Do not use any other chargers than those recommended.
- Do not use the device where wireless devices are not allowed.
- Adapter shall be easily accessible.
- Use only power supplies which are provided by manufacturer and in the original packing of this product. If you have any questions, please don't hesitate to contact us.
- Keep the device away from fire or hot environments. DO NOT immerse in water or any other liquid.
- Do not disassemble, repair or modify the product.
- Do not place near automatically controlled devices such as fire alarms. Radio waves emitted from this product may cause such devices to malfunction resulting in an accident.
- Observe restrictions on using wireless products in fuel depots, chemical plants or when blasting operations are in progress.
- Do not use liquid to clean the product. Only use a dry cloth.
- Never put metal objects inside the product. If a metal object enters the product turn off the circuit breaker and contact an authorised electrician.
- This product is not intended to be used when providing medical care. Consult the manufacturer of any personal medical devices, such as pacemakers or hearing aids to determine if they are adequately shielded from external RF (radio frequency) energy.
- Do not use this product in health care facilities. Hospitals or health care facilities may be using equipment that could be sensitive to external RF energy.
- Do not place heavy objects on top of the product.
- When you leave the product unused for a long time unplug the product from the power outlet.
- Product should be kept away from heat sources such as radiators, cookers etc. - it should not be placed in places where the temperature is less than -20 degrees or greater than 45 degrees.
- This product may interfere with other electronic products such as TV, radios, personal computers, phones or other wireless devices.
- Adapter should be used indoors where the ambient temperature is lower than or equal to 40 °C.
- Always follow the local waste and recycle laws when you get rid of the used battery.

CAUTION!

Risk of fire or explosion
if the battery is replaced by an incorrect type

CAUTION!

Avoid replacement of a battery with an incorrect type that can defeat a safeguard.

Avoid disposal of a battery into fire or a hot oven, or mechanically crushing or cutting of a battery, that can result in an explosion.

Do not leave a battery in an extremely high temperature surrounding environment that can result in an explosion or the leakage of flammable liquid or gas; Do not leave a battery subjected to extremely low air pressure that may result in an explosion or the leakage of flammable liquid or gas.

Camera Operating Temperature: -20 °C ~ 45 °C (-4 °F ~ 113 °F)
 Camera Operating Humidity: 10%~90%RH, Non-condensing
 Hub Operating Temperature: 0 °C ~ 40 °C (32 °F ~ 104 °F)
 Hub Operating Humidity: 10%~90%RH, Non-condensing
 Please read and follow the above safety information when operating the device. We cannot guarantee that no accidents or damage will occur due to improper use of the device. Please use this product with care and operate at your own risk.

TP-Link hereby declares that the device is in compliance with the essential requirements and other relevant provisions of directives 2014/53/EU, 2009/125/EC, 2011/65/EU and (EU)2015/863.

The original EU declaration of conformity may be found at <https://www.tapo.com/support/ce>

TP-Link hereby declares that the device is in compliance with the essential requirements and other relevant provisions of the Radio Equipment Regulations 2017.

The original UK declaration of conformity may be found at <https://www.tapo.com/support/ukca/>



©2023 TP-Link



Visit www.tapo.com/support
for technical support, user guides,
and more information

