

# GEL-12-200

Valve-regulated lead-acid battery



## GEL SERIES

### Characteristics

Nominal voltage	12V (6 cell per unit)	
Nominal capacity at 10 hours rate/10.8V (25°C)	200Ah	
Capacity (25°C)	20 Hours rate/10.8V	212Ah
	5 Hours rate/10.8V	165Ah
Terminal type	T18	
Torque	12.3±2.5N.m	
Approx. internal resistance (25°C)	3.3 mΩ	
Dimensions	Length	522±2mm (20.55inch)
	Width	238±2mm (9.37inch)
	Height	218±2mm (8.58inch)
	Total height	222±2mm (8.74inch)
Design Life (stand-by)	JIS at 25°C	12 years
	Eurobat at 20°C	10/12 years
Weight	62.50kg (137.80lbs)±3%	
Nominal operating temperature	25°C±3 (77±5°F)	
Operating temperature range	Discharge	-15°C~50°C (5°F~122°F)
	Charge	-10°C~50°C (14°F~122°F)
	Storage	-20°C~50°C (-4°F~122°F)
Float charging voltage at 25°C	13.5V~13.8V	
Cyclic charging voltage at 25°C	14.5V~14.7V	
Temperature compensation	Float charge	-18 mV/°C/Block
	Cycle charge	-30 mV/°C/Block
Max. charging current (A)	40A	
Max. discharge current for 5 seconds	1400A	
Self discharge rate (25°C)	≤3%/month	
Battery container ABS UL94-HB	V-0 optional	

### Overview

GEL Series are manufactured following the highest demands in the deep cycle and renew-able energy applications. The batteries use colloidal or foamed silica gel to immobilize the electrolyte, which further enhances the cycling stability. Available in top and front terminal types.

### Dimensions & Terminal Type (mm)

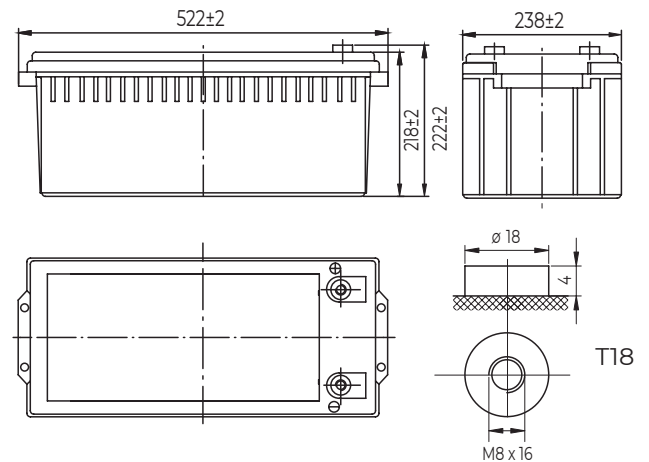

### Construction

Component	Positive Plate	Negative plate	Container	Separator	Electrolyte	Safety valve	Terminal
Raw material	Lead dioxide	Lead	ABS (V-0 opt.)	AGM	Sulfuric Acid Gel	Rubber	Copper

### Constant current discharge characteristics at 25°C

(Ampere/battery)

F.V/Time	15min	30min	60min	2h	3h	4h	5h	6h	8h	10h	20h
9.60V	320	194	120	73.1	52.0	40.8	34.7	30.6	24.5	20.4	10.8
9.90V	312	190	118	72.6	51.7	40.6	34.5	30.4	24.3	20.3	10.8
10.2V	301	184	115	72.0	51.4	40.3	34.2	30.2	24.2	20.3	10.7
10.5V	291	180	112	70.9	51.0	40.0	34.0	30.0	24.0	20.1	10.7
10.8V	275	173	108	69.1	50.0	38.8	33.0	29.1	23.3	20.0	10.6

### Constant power discharge characteristics at 25°C

(Watts/battery)

F.V/Time	15min	30min	60min	2h	3h	4h	5h	6h	8h	10h	20h
9.60V	3514	2177	1368	846	612	480	410	362	291	243	129
9.90V	3429	2133	1347	841	608	477	408	360	289	243	129
10.2V	3303	2068	1313	834	604	474	405	357	287	242	129
10.5V	3190	2018	1272	821	600	470	402	355	285	240	128
10.8V	3022	1944	1231	800	588	456	390	344	277	239	127

The above characteristics represent average values and can be obtained within three charge and discharge cycles. The batteries must be fully charged before testing. The data in this document is subject to change without notice and become contractual only after written confirmation. Please contact **Conexpro** for the latest available version.

### Discharge characteristics (25°C)

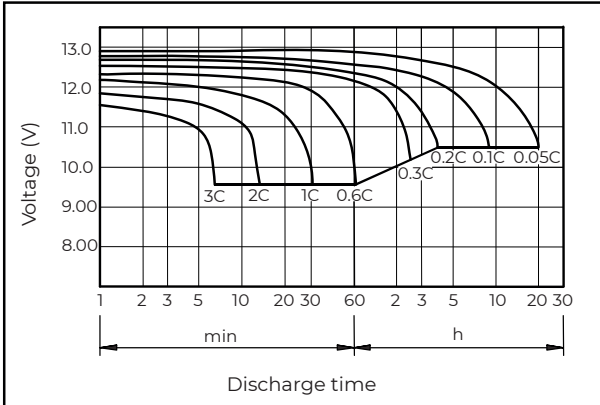

### Charging characteristics (25°C)

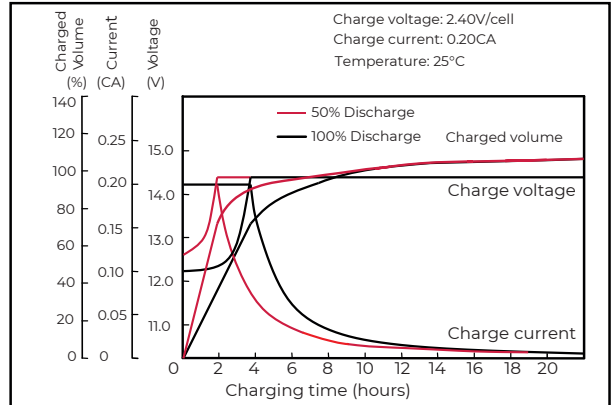

### Temperature effects on capacity

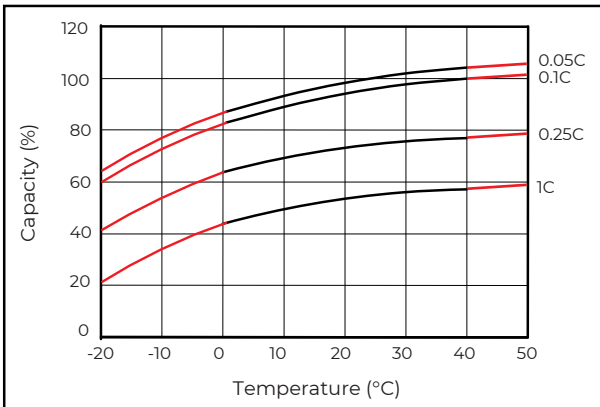

### Self-discharge characteristics

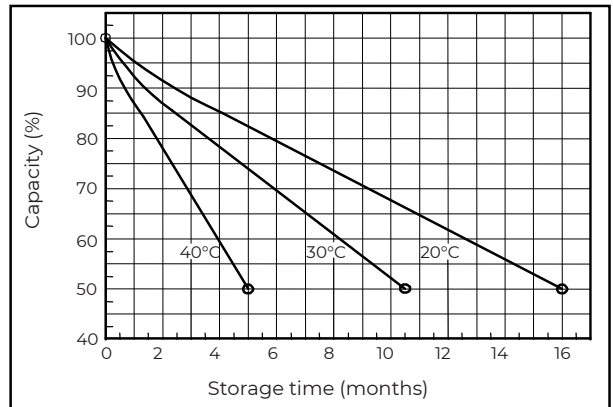

### Floating life on temperature

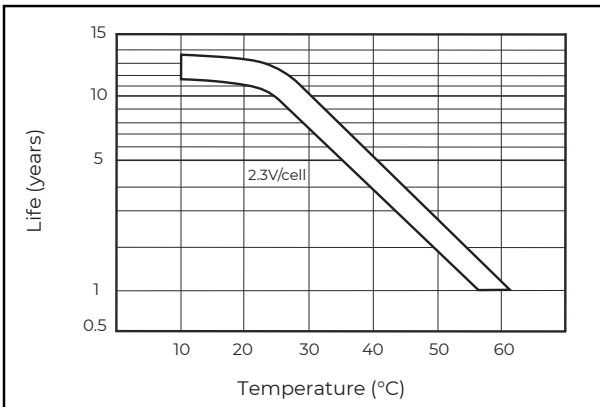

### Cycle life on D.O.D (25°C)

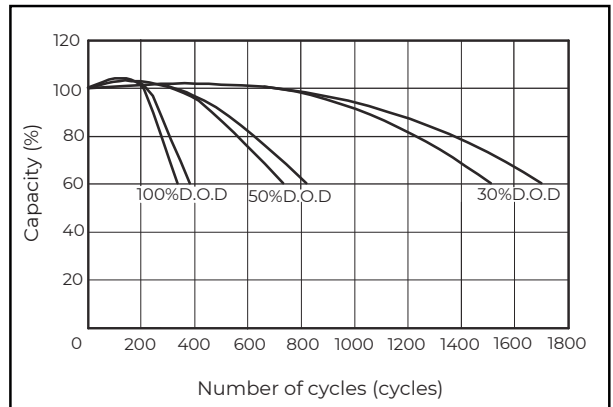

### Relationship for OCV and capacity (25°C)

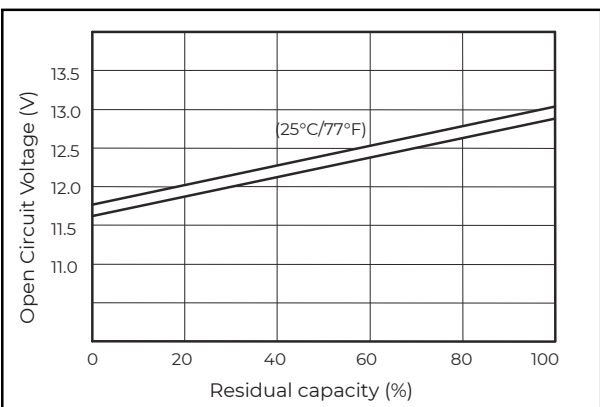

### Charging voltage VS temperature

